

Hydraulic Crawler Crane

CKS

800

Model : CKS800

Max. Lifting Capacity: **80 t x 3.0 m**

Max. Crane Boom Length: **54.9 m**

Max. Fixed Jib Combination: **42.7 m + 18.3 m 45.7 m + 12.2 m**

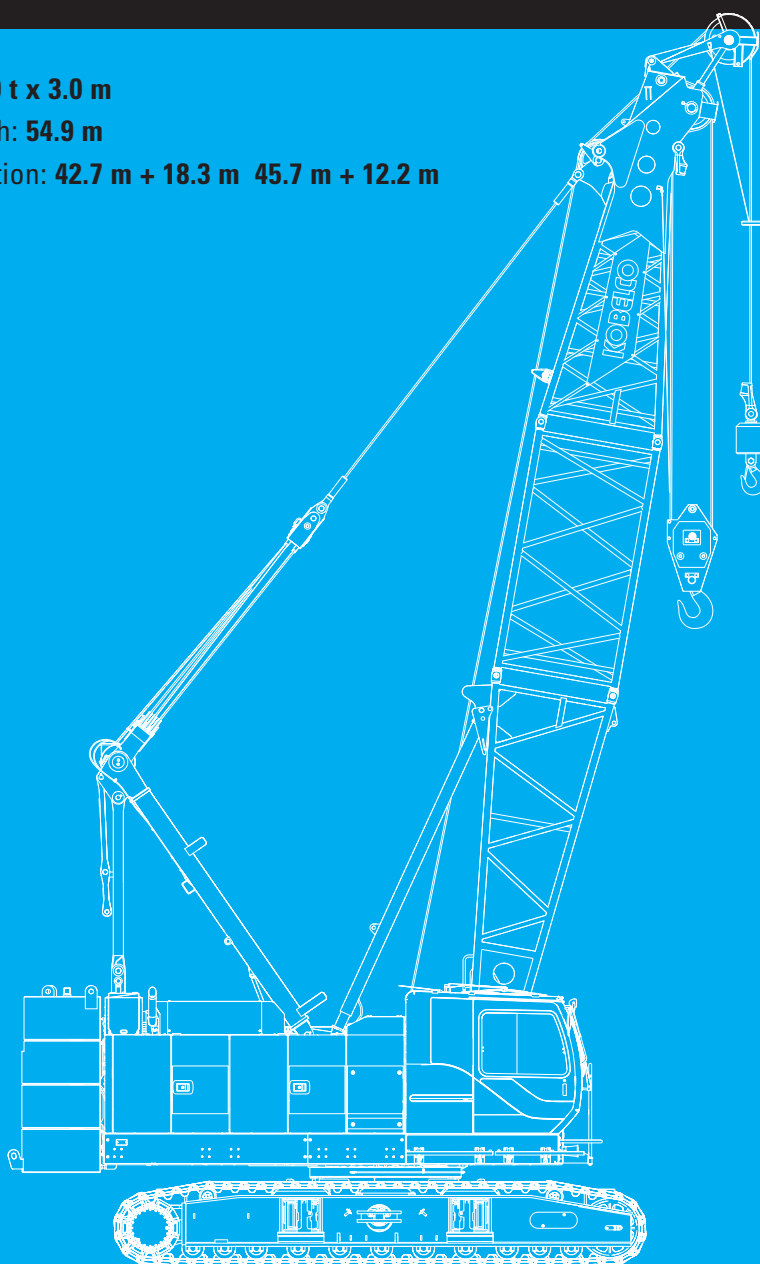

KOBELCO



CKS800

CONTENTS

3	SPECIFICATIONS
5	GENERAL DIMENSIONS
6	BOOM AND JIB ARRANGEMENTS
7	WORKING RANGES
10	SUPPLEMENTAL DATA
11	LIFTING CAPACITIES
14	SUPPLEMENTAL DATA FOR CLAMSHELL
15	LIFTING CAPACITIES
16	SUPPLEMENTAL DATA FOR REDUCED WEIGHTS
17	LIFTING CAPACITIES
18	SUPPLEMENTAL DATA FOR BARGE
19	LIFTING CAPACITIES
20	TRANSPORTATION PLAN
21	PARTS AND ATTACHMENTS

SPECIFICATIONS



Power Plant

Model: HINO J08E-VM

Type: 4 cycle, water-cooled, vertical in-line 6, direct injection, turbo-charger, intercooler

Displacement: 7,684 liters

Rated power: 213 kW/2,100 min⁻¹

Max. Torque: 1,017 N·m/1,600 min⁻¹

Cooling System: Water-cooled

Starter: 24V-5kW

Radiator: Corrugated type core, thermostatically controlled

Air cleaner: Dry type with replaceable paper element

Throttle: Twist grip type hand throttle, electrically actuated

Fuel filter: Replaceable paper element

Batteries: Two 12V x 136 Ah/5HR capacity batteries, series connected

Fuel tank capacity: 400 liters



Hydraulic System

Main pumps: 3 variable displacement piston pumps

Control: Full-flow hydraulic control system for infinitely variable pressure to all winches, propel and swing. Controls respond instantly to the touch, delivering smooth function operation.

Cooling: Oil-to-air heat exchanger (plate-fin type)

Filtration: Full-flow and bypass type with replaceable element

Max. relief valve pressure:

Load hoist, boom hoist and propel system: 31.9 MPa

Swing system: 27.5 MPa

Control system: 5.4 MPa

Hydraulic Tank Capacity: 440 liters



Boom Hoisting System

Powered by a hydraulic motor through a planetary reducer.

Brake: A spring-set, hydraulically released multiple-disc brake is mounted on the boom hoist motor and operated through a counter-balance valve.

Drum Lock: External ratchet for locking drum

Drum: Single drum, grooved for 16mm dia. wire rope

Line Speed: Single line on first drum layer

Hoisting/Lowering: 70 to 2 m/min

Boom hoisting/lowering: 16 mm x 150 m

Boom guy line: 30 mm

Boom backstops: Required for all boom length



Load Hoisting System

Front and rear drums for load hoist powered by a hydraulic variable plunger motors, driven through planetary reducers.

Negative Brake: A spring-set, hydraulically released multiple-disc brake is mounted on the hoist motor and operated through a counter-balance valve. (Positive free fall brake is optional)

Drum Lock: External ratchet for locking drum

Drums:

Front Drums:

550 mm P.C.D x 545 mm wide drum, grooved for 22 mm wire rope. Rope capacity is 220 m working length and 335 m storage length.

Rear Drum: 550 mm P.C.D x 545 mm grooved for 22 mm wire rope. Rope capacity is 130 m working length and 335m storage length.

Diameter of wire rope

Main winch: 22 mm x 220 m

Aux. winch: 22 mm x 130 m

Third winch: 22 mm x 145 m

Line Speed*:

Hoisting/lowering: 120 to 3 m/min

Line Pull:

Max. Line Pull*: 153 kN {15.5 tf}

(Referential performance)

Rated Line Pull: 78 kN {8.0 tf}

*Single line on first drum layer



Swing System

Swing unit is powered by hydraulic motor driving spur gears through planetary reducer, the swing system provides 360° rotation.

Swing parking brakes: A spring-set, hydraulically released multiple-disc brake is mounted on swing motor.

Swing circle: Single-row ball bearing with an integral internally cut swing gear.

Swing lock: Manually, four position lock for transportation

Swing Speed: 4.0 min⁻¹



Upper Structure

Torsion-free precision machined upper frame. All components are located clearly and service friendly. Engine will with low noise level.

Counterweight: 27.2 ton



Cab & Control

Totally enclosed, full vision cab with safety glass, fully adjustable, high backed seat with a headrest and armrests, and intermittent wiper and window washer (skylight and front window).

Cab fittings:

Air conditioner, convenient compartment (for tool), cup holder, cigarette lighter, sun visor, roof blind, tinted glass, floor mat, footrest, and shoe tray



Lower Structure

Steel-welded carbody with axles. Crawler assemblies can be hydraulically extended for wide-track operation or retracted for transportation. Crawler belt tension is maintained by hydraulic jack force on the track-adjusting bearing block.

Carbodyweight: 6.5 ton

Crawler drive: Independent hydraulic propel drive is built into each crawler side frame. Each drive consists of a hydraulic motor propelling a driving tumbler through a planetary gear box. Hydraulic motor and gear box are built into the crawler side frame within the shoe width.

Crawler brakes: Spring-set, hydraulically released parking brakes are built into each propel drive.

Steering mechanism: A hydraulic propel system provides both skid steering (driving one track only) and counter-rotating steering (driving each track in opposite directions).

Track rollers: Sealed track rollers for maintenance-free operation.

Shoe (flat): 800 mm wide each crawler

Max. gradeability: 40%



Weight

Including upper and lower machine, 27.2 ton counterweight and 6.5 ton carbody weight, basic boom (or basic boom + basic jib), hook, and other accessories.

Weight: 75.1 ton

Ground pressure: 84.7 kPa



Attachment

Boom & Jib:

Welded lattice construction using tubular, high-tensile steel chords with pin connection between sections.

Boom and Jib length

	Min. Length (Min. combination)	Max. Length (Max. combination)
Crane Boom	9.1 m	54.9 m
Fixed Jib	30.5 m + 6.1 m	42.7 m + 18.3 m, 45.7 m + 12.2 m

Main Specifications (Model: CKS800)

Crane Boom	
Max. Lifting Capacity	80 t x 3.0 m
Max. Length	54.9 m
Fixed Jib	
Max. Lifting Capacity	7.0 t x 20.0 m
Max. Combination	42.7 m + 18.3, 45.7 m + 12.2 m
Main & Aux. Winch	
Max. Line Speed (1st layer)	120 m/min
Rated Line Pull (Single line)	78 kN {8 tf}
Wire Rope Diameter	22 mm
Wire Rope Length	220 m (Main), 130 m (Aux.)
Brake Type (free fall)	Wet-type multiple disc brake (Optional)
Working Speed	
Swing Speed	4.0 min ⁻¹ {rpm}
Travel Speed	1.7/1.1 km/h
Power Plant	
Model	HINO J08E-VM
Engine Output	213 kW/2,100 min ⁻¹
Fuel Tank	400 liters

Hydraulic System

Main Pumps	3 variable displacement
Max. Pressure	31.9 MPa {325 kgf/cm ² }
Hydraulic Tank Capacity	440 liters

Self-Removal Device

	Counterweight/self-removal device (Option)
--	--

Weight

Operating Weight	75.1 t * ¹
Ground Pressure	84.7 kPa
Counterweight	27,200 kg
Transport Weight	39,850 kg * ²

Units are SI units. { } indicates conventional units.

Line speeds in table are for light loads. Line speed varies with load.

*¹ Including upper and lower machine, 27.2 ton counterweight, 6.5 ton carbody weight, basic boom, hook, and other accessories.

*² Base machine with boom base, gantry, crawlers, and wire ropes (front/boom hoist)

GENERAL DIMENSIONS

(Unit: mm)

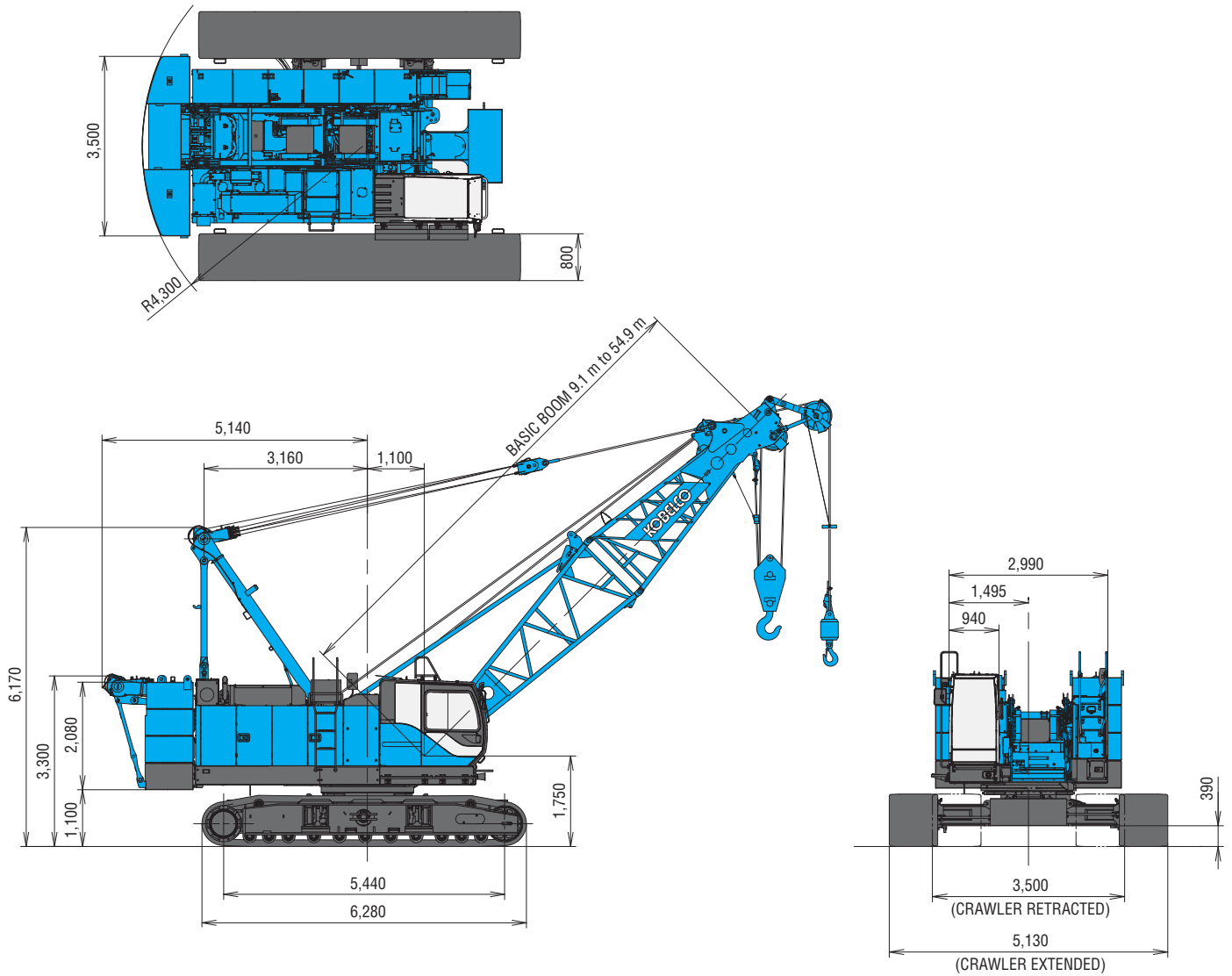

This catalog may contain photographs of machines with specifications, attachments and optional equipment.

Limit of Hook Lifting

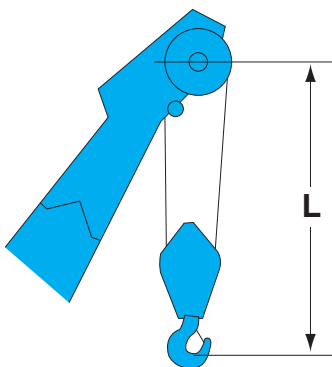

Hook	L
80 t hook	4.5 m
50 t hook	4.3 m
32 t hook	4.2 m
19 t hook	4.1 m

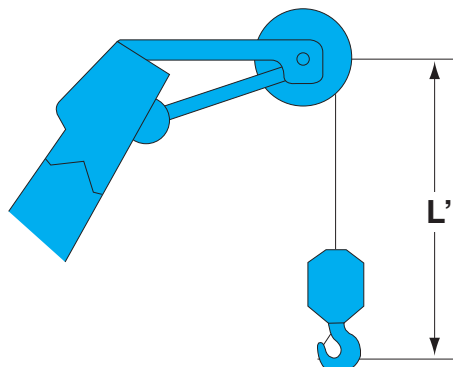

Hook	L'
Ball hook	3.1 m

BOOM AND JIB ARRANGEMENTS

Crane Boom Arrangements

Boom length m (ft)	Boom arrangement
9.1 (30)	※
12.2 (40)	※
15.2 (50)	 ※
18.3 (60)	※
21.3 (70)	 ※
24.4 (80)	※
27.4 (90)	※
30.5 (100)	 ※
33.5 (110)	 ※
36.6 (120)	※

Boom length m (ft)	Boom arrangement
39.6 (130)	 ※
42.7 (140)	 ※
45.7 (150)	※
48.8 (160)	 ※
51.8 (170)	※
54.9 (180)	※

Symbol	Boom Length	Remarks
	5.2 m	Boom Base
	3.9 m	Boom Top
	3.0 m	Insert Boom
	6.1 m	Insert Boom
	6.1 m	Insert Boom with lug
	9.1 m	Insert Boom
	9.1 m	Insert Boom with lug

↗ mark shows the guy line installing position when the fixed jib is used.

※ indicates the most flexible combination of insert luffing booms, which can be modified to form all shorter luffing boom arrangements.

Fixed Jib Arrangements

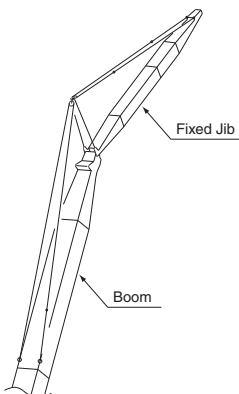

Crane boom length	Jib length m (ft)	Jib arrangement
30.5 m ~ 45.7 m	6.1 (20)	
	12.2 (40)	
30.5 m ~ 42.7 m	18.3 (60)	

Symbol	Jib Length	Remarks
	3.0 m	Jib Base
	3.0 m	Jib Top
	6.1 m	Insert Jib

Crane Boom

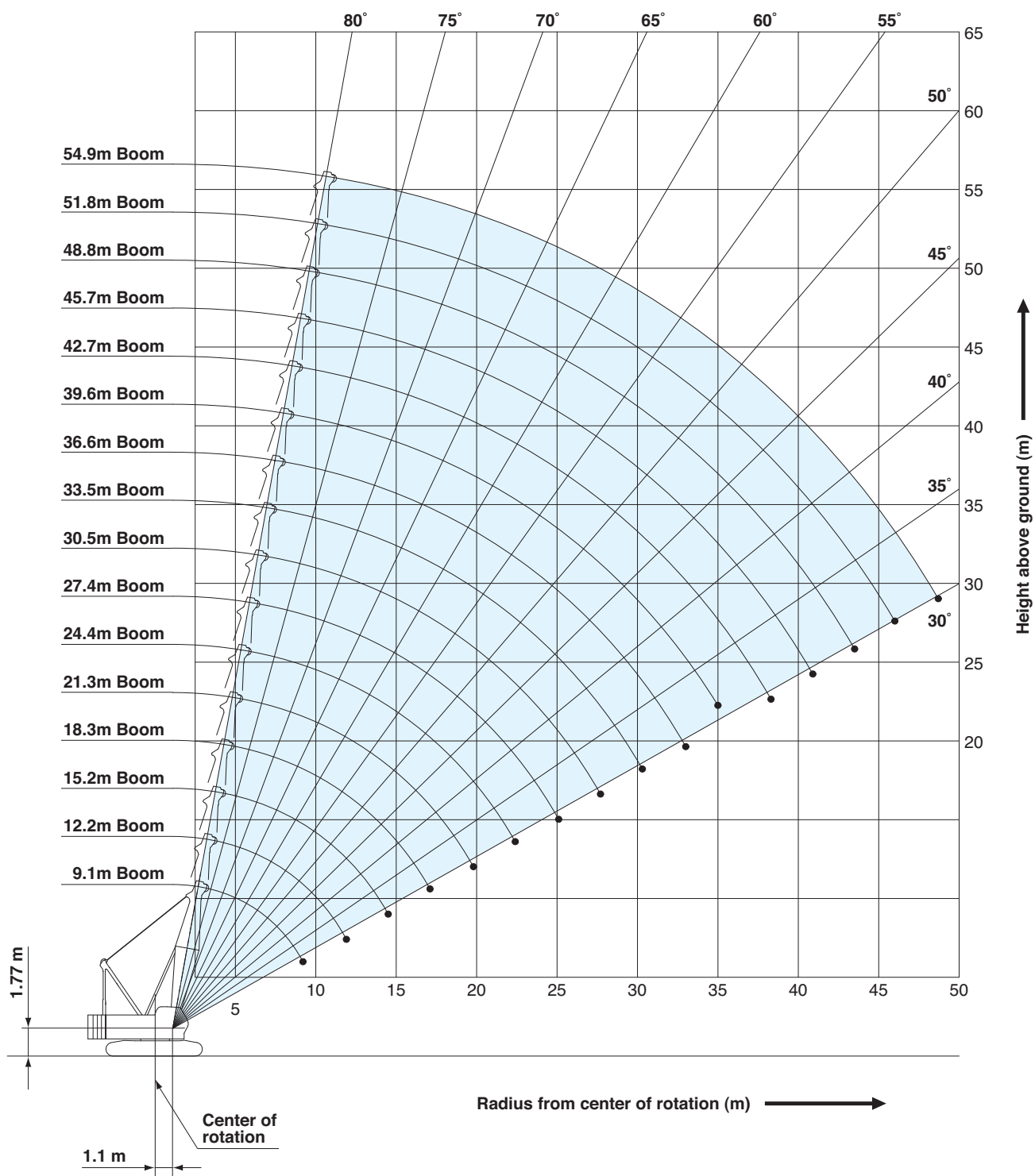

Fixed Jib 10°

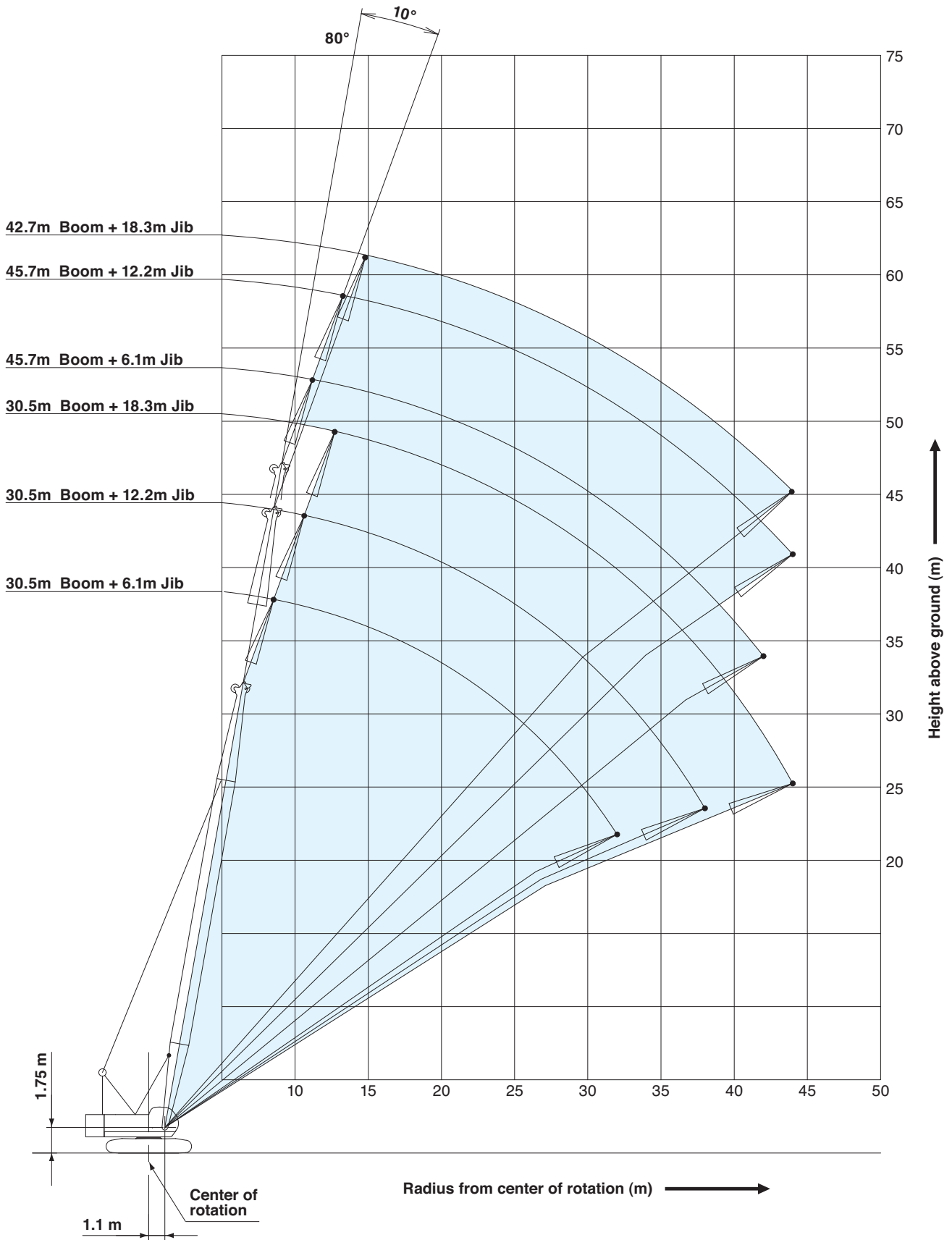

Fixed Jib 30°

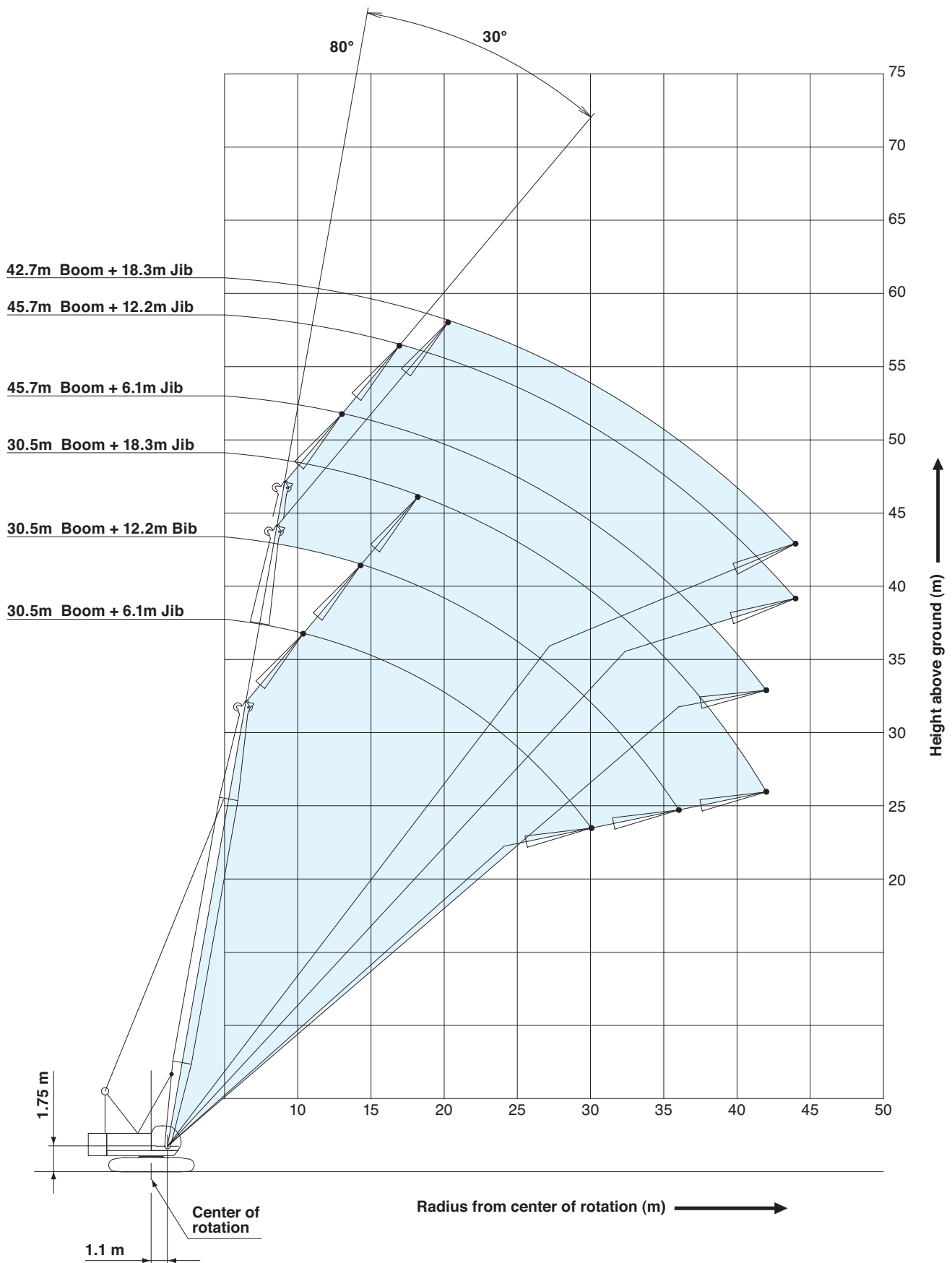

SUPPLEMENTAL DATA

- Ratings according to EN13000.
- Operating radius is the horizontal distance from centerline of rotation to a vertical line through the center of gravity of the load.
- Deduct weight of hook block (s), slings and all other load handling accessories from main boom ratings shown.
- Ratings shown are based on freely suspended loads and make no allowance for such factors as wind effect on lifted load, ground conditions, out-of-level, operating speeds or any other condition that could be detrimental to the safe operation of this equipment.
The operator, therefore, has the responsibility to judge the existing conditions and reduce lifted loads and operating speeds accordingly.
- Ratings are for operation on a firm and level surface, up to 1 % gradient.
- At radii and boom lengths where no ratings are shown on chart, operation is not intended nor approved.
- Boom inserts and guy lines must be arranged as shown in the "operator's manual".
- Boom hoist reeving is 12 part line.
- Gantry must be in raised position for all conditions.
- Boom backstops are required for all boom lengths.
- The boom should be erected over the front of the crawlers, not laterally.
- Ratings inside of boxes are limited by strength of materials.
- The minimum rated load is 1.1 (ton).
- Crawler frames must be fully extended for all crane operations.
- When erecting or lowering the boom length of 54.9 m (180 ft) or over, the blocks for erection must be placed under the front of the crawlers.

(Crane boom lifting)

- The total load that can be lifted is the value for weight of main hook block, slings, and all other load handling accessories deducted from crane boom ratings shown.

(Fixed jib lifting)

- The total load that can be lifted is the value for weight of jib hook block, slings, and all other load handling accessories deducted from fixed jib ratings shown.
- The availability of fixed jib mounting
 - On crane boom : Range 30.5 m to 45.7 m.
 But 18.3 m jib is not allowed to install on 45.7 m main boom.

<Reference Information>

Main hoist loads

No. of Parts of Line	1	2	3	4	5
Maximum Loads (kN)	78	157	235	314	392
Maximum Loads (t)	8.0	16.0	24.0	32.0	40.0

No. of Parts of Line	6	7	8	9	10
Maximum Loads (kN)	471	549	628	706	785
Maximum Loads (t)	48.0	56.0	64.0	72.0	80.0

Auxiliary hoist loads

No. of Parts of Line	1
Maximum Loads (kN)	69
Maximum Loads (t)	7.0

Weight of hook block					
Hook Block	80 t	50 t	32 t	19 t	Ball Hook
Weight (t)	0.8	0.7	0.5	0.4	0.16

Operation of this equipment in excess of rated loads or disregard of instruction voids the warranty.

Assembling the counterweight

27.2 ton counterweight
6.5 ton carbody weight
(standard type)

No.4		No.5
No.3		
No.2		
No.1		

Counterweights



Carbody weights

Assembling the counterweight

(Equipped with self removal device)
26.1 ton counterweight
6.5 ton carbody weight
(optional type)

No.4		No.5
No.2		No.3
No.1		

Counterweights



Carbody weights

- The lifting capacity does not change due to the type of counterweights (standard or optional).

LIFTING CAPACITIES



Crane Boom Lifting Capacities

Counterweight: 27.2 t

Carbody Weight: 6.5 t

Unit: metric ton

Working radius (m)	Boom length (m)	9.1	12.2	15.2	18.3	21.3	24.4	27.4	30.5	33.5	36.6	39.6	42.7	45.7	48.8	51.8	54.9	Boom length (m)	Working radius (m)
		3.0	3.6m/76.2																
3.0	80.0	3.6m/76.2																	3.0
4.0	69.0	72.6	4.2m/69.6	4.7m/59.3															4.0
5.0	57.9	57.7	57.5	55.1	5.2m/50.0	5.7m/42.9													5.0
6.0	47.5	47.3	46.7	44.6	42.6	40.8	6.3m/37.2	6.8m/33.0											6.0
7.0	39.8	39.6	38.9	37.3	35.8	34.5	33.3	32.0	7.3m/29.5	7.9m/26.4									7.0
8.0	32.9	32.7	32.5	32.0	30.9	29.8	28.8	27.8	26.9	26.0	8.4m/24.0								8.0
9.0	26.0	27.8	27.6	27.5	27.0	26.2	25.4	24.5	23.8	23.1	22.4	21.7	9.4m/20.1						9.0
10.0	9.2m/24.5	24.1	23.9	23.8	23.7	23.3	22.6	21.9	21.3	20.6	20.0	19.4	19.0	18.4	10.5m/17.1	11.0m/15.7			10.0
12.0		11.9m/19.3	18.8	18.7	18.6	18.5	18.4	17.9	17.4	16.9	16.5	16.0	15.6	15.1	14.8	14.4			12.0
14.0			15.4	15.3	15.1	15.0	14.9	14.8	14.7	14.2	13.9	13.5	13.2	12.8	12.5	12.1			14.0
16.0			14.5m/14.7	12.9	12.7	12.6	12.5	12.3	12.2	12.1	11.9	11.5	11.3	10.9	10.7	10.4			16.0
18.0				17.1m/11.8	10.9	10.8	10.7	10.5	10.4	10.3	10.2	10.0	9.8	9.4	9.3	9.0			18.0
20.0					19.8m/9.6	9.3	9.2	9.1	9.0	8.8	8.7	8.6	8.5	8.3	8.1	7.8			20.0
22.0						8.2	8.1	7.9	7.8	7.7	7.6	7.5	7.4	7.2	7.1	6.9			22.0
24.0						22.4m/8.0	7.2	7.0	6.9	6.8	6.6	6.5	6.4	6.3	6.2	6.1			24.0
26.0							25.1m/6.8	6.2	6.1	6.0	5.9	5.7	5.6	5.5	5.4	5.3			26.0
28.0								27.7m/5.7	5.5	5.4	5.2	5.1	5.0	4.9	4.8	4.7			28.0
30.0									4.9	4.8	4.7	4.5	4.4	4.3	4.2	4.1			30.0
32.0									30.3m/4.9	4.3	4.2	4.0	3.9	3.8	3.7	3.6			32.0
34.0										33.0m/4.1	3.8	3.6	3.5	3.4	3.3	3.2			34.0
36.0											35.0m/3.5	3.3	3.2	3.0	2.9	2.8			36.0
38.0												2.9	2.8	2.7	2.6	2.5			38.0
40.0												38.3m/2.9	2.6	2.4	2.3	2.2			40.0
42.0													40.9m/2.4	2.1	2.0	1.9			42.0
44.0														43.5m/2.0	1.8	1.7			44.0
46.0															1.6	1.5			46.0
48.0																1.3			48.0
50.0																	48.7m/1.2		50.0
Reeves	10	10	9	8	7	6	5	5	4	4	3	3	3	3	3	2			Reeves

Note:

Ratings according to EN13000.

Ratings shown in are determined by the strength of the boom or other structural components.

Lifting capacities may vary depending on hook used or with/without auxiliary sheave.

Please refer rated chart in operator's cabin.



Fixed Jib Lifting Capacities (Jib Offset Angle : 10°)

Counterweight: 27.2 t
Carbody Weight: 6.5 t

Unit: metric ton

Boom length (m)	30.5			33.5			36.6			Boom length (m)
Jib length (m)	6.1	12.2	18.3	6.1	12.2	18.3	6.1	12.2	18.3	Jib length (m)
9.0	7.0			7.0						9.0
10.0	7.0			7.0			7.0			10.0
12.0	7.0	7.0	4.5	7.0	7.0		7.0	7.0		12.0
14.0	7.0	7.0	4.5	7.0	7.0	4.5	7.0	7.0	4.5	14.0
16.0	7.0	7.0	4.5	7.0	7.0	4.5	7.0	7.0	4.5	16.0
18.0	7.0	7.0	4.5	7.0	7.0	4.5	7.0	7.0	4.5	18.0
20.0	6.8	7.0	4.5	6.8	6.9	4.5	6.7	6.9	4.5	20.0
22.0	6.1	6.4	4.5	6.0	6.2	4.5	5.9	6.2	4.5	22.0
24.0	5.4	5.6	4.5	5.2	5.5	4.5	5.1	5.4	4.5	24.0
26.0	4.7	5.0	4.5	4.6	4.8	4.5	4.5	4.8	4.5	26.0
28.0	4.2	4.4	4.5	4.1	4.3	4.4	4.0	4.2	4.3	28.0
30.0	3.8	4.0	4.1	3.6	3.8	3.9	3.5	3.7	3.9	30.0
32.0	3.4	3.6	3.7	3.2	3.4	3.5	3.1	3.3	3.5	32.0
34.0		3.2	3.3	2.9	3.1	3.2	2.8	3.0	3.1	34.0
36.0		2.9	3.0	2.6	2.8	2.9	2.5	2.7	2.8	36.0
38.0		2.6	2.8		2.5	2.6	2.2	2.4	2.5	38.0
40.0			2.5		2.3	2.4		2.1	2.3	40.0
42.0			2.3		2.0	2.1		1.9	2.0	42.0
44.0			2.1			1.9		1.6	1.8	44.0
Reeves	1	1	1	1	1	1	1	1	1	Reeves

Boom length (m)	39.6			42.7			45.7			Boom length (m)
Jib length (m)	6.1	12.2	18.3	6.1	12.2	18.3	6.1	12.2		Jib length (m)
10.0	7.0									10.0
12.0	7.0			7.0			7.0			12.0
14.0	7.0	7.0	4.5	7.0	7.0	4.5	7.0	7.0		14.0
16.0	7.0	7.0	4.5	7.0	7.0	4.5	7.0	7.0		16.0
18.0	7.0	7.0	4.5	7.0	7.0	4.5	7.0	7.0		18.0
20.0	6.6	6.7	4.5	6.6	6.7	4.5	6.5	6.6		20.0
22.0	5.8	6.0	4.5	5.7	6.0	4.5	5.6	5.8		22.0
24.0	5.0	5.3	4.5	4.9	5.2	4.5	4.8	5.1		24.0
26.0	4.4	4.6	4.5	4.3	4.5	4.5	4.2	4.4		26.0
28.0	3.9	4.1	4.2	3.8	4.0	4.1	3.6	3.9		28.0
30.0	3.4	3.6	3.7	3.3	3.5	3.6	3.2	3.4		30.0
32.0	3.0	3.2	3.3	2.9	3.1	3.2	2.7	3.0		32.0
34.0	2.6	2.9	3.0	2.5	2.8	2.9	2.3	2.6		34.0
36.0	2.3	2.5	2.7	2.2	2.4	2.6	2.0	2.2		36.0
38.0	2.0	2.2	2.4	1.8	2.1	2.2	1.6	1.9		38.0
40.0	1.7	1.9	2.1	1.6	1.8	2.0	1.4	1.6		40.0
42.0		1.7	1.8	1.3	1.6	1.7	1.1	1.4		42.0
44.0		1.4	1.6	1.1	1.3	1.5		1.1		44.0
Reeves	1	1	1	1	1	1	1	1		Reeves

Note:

Ratings according to EN13000.

Ratings shown in are determined by the strength of the boom or other structural components.

Lifting capacities may vary depending on hook used or with/without auxiliary sheave.

Please refer rated chart in operator's cabin.

LIFTING CAPACITIES



Fixed Jib Lifting Capacities (Jib Offset Angle : 30°)

Counterweight: 27.2 t
Carbody Weight: 6.5 t

Unit: metric ton

Boom length (m)	30.5			33.5			36.6			Boom length (m)
Jib length (m)	6.1	12.2	18.3	6.1	12.2	18.3	6.1	12.2	18.3	Jib length (m)
12.0	7.0			7.0			7.0			12.0
14.0	7.0			7.0			7.0			14.0
16.0	7.0	5.0		7.0	5.0		7.0	5.0		16.0
18.0	7.0	5.0	3.2	7.0	5.0	3.2	7.0	5.0		18.0
20.0	6.9	5.0	3.2	6.8	5.0	3.2	6.8	5.0	3.2	20.0
22.0	6.2	5.0	3.2	6.1	5.0	3.2	6.1	5.0	3.2	22.0
24.0	5.5	5.0	3.2	5.4	5.0	3.2	5.3	5.0	3.2	24.0
26.0	4.8	4.9	3.2	4.7	5.0	3.2	4.6	5.0	3.2	26.0
28.0	4.3	4.6	3.2	4.2	4.5	3.2	4.1	4.4	3.2	28.0
30.0	3.8	4.1	3.1	3.7	4.0	3.2	3.6	3.9	3.2	30.0
32.0		3.7	3.0	3.3	3.6	3.0	3.2	3.5	3.1	32.0
34.0		3.3	2.8		3.2	2.9	2.9	3.1	3.0	34.0
36.0		3.0	2.7		2.9	2.8		2.8	2.9	36.0
38.0			2.6		2.6	2.7		2.5	2.7	38.0
40.0			2.5			2.5		2.2	2.5	40.0
42.0			2.4			2.3			2.2	42.0
44.0						2.1			2.0	44.0
Reeves	1	1	1	1	1	1	1	1	1	Reeves

Boom length (m)	39.6			42.7			45.7			Boom length (m)
Jib length (m)	6.1	12.2	18.3	6.1	12.2	18.3	6.1	12.2		Jib length (m)
12.0	7.0									12.0
14.0	7.0			7.0			7.0			14.0
16.0	7.0	5.0		7.0			7.0			16.0
18.0	7.0	5.0		7.0	5.0		7.0	5.0		18.0
20.0	6.6	5.0	3.2	6.6	5.0	3.2	6.6	5.0		20.0
22.0	5.9	5.0	3.2	5.9	5.0	3.2	5.8	5.0		22.0
24.0	5.2	5.0	3.2	5.1	5.0	3.2	5.0	5.0		24.0
26.0	4.5	4.9	3.2	4.4	4.8	3.2	4.3	4.7		26.0
28.0	4.0	4.3	3.2	3.9	4.3	3.2	3.8	4.2		28.0
30.0	3.5	3.8	3.2	3.4	3.8	3.2	3.3	3.7		30.0
32.0	3.1	3.4	3.2	3.0	3.3	3.2	2.9	3.2		32.0
34.0	2.7	3.0	3.1	2.6	3.0	3.2	2.4	2.9		34.0
36.0	2.3	2.7	2.9	2.2	2.6	2.8	2.1	2.5		36.0
38.0	2.0	2.4	2.6	1.9	2.3	2.5	1.7	2.1		38.0
40.0		2.1	2.3	1.6	2.0	2.3	1.4	1.8		40.0
42.0		1.8	2.1		1.7	2.0	1.2	1.5		42.0
44.0		1.5	1.8		1.4	1.7		1.3		44.0
Reeves	1	1	1	1	1	1	1	1		Reeves

Note:

Ratings according to EN13000.

Ratings shown in are determined by the strength of the boom or other structural components.

Lifting capacities may vary depending on hook used or with/without auxiliary sheave.

Please refer rated chart in operator's cabin.

SUPPLEMENTAL DATA FOR CLAMSHELL RATING CHART

- Operating radius is the horizontal distance from centerline of rotation to a vertical line through the center of gravity of the load.
- Deduct weight of bucket, slings and all other load handling accessories from main boom ratings shown.
- Ratings shown are based on freely suspended loads and make no allowance for such factors as wind effect on lifted load, ground conditions, out-of-level, operating speeds or any other condition that could be detrimental to the safe operation of this equipment. The operator, therefore, has the responsibility to judge the existing conditions and reduce lifted loads and operating speeds accordingly.
- Rated loads do not exceed 66% of minimum tipping loads.
- Ratings are for operation on a firm and level surface, up to 1% gradient.
- At radii and boom lengths where no ratings are shown on chart, operation is not intended nor approved.
- Boom inserts and guy lines must be arranged as shown in the "operator's manual".
- Boom hoist reeving is 12 part line.
- Gantry must be in raised position for all conditions.
- Boom backstops are required for all boom lengths.
- The boom should be erected over the front of the crawlers, not laterally.
- Crawler frames must be fully extended for all crane operations.

(Clamshell bucket lifting)

- The total load that can be lifted is the value for weight of bucket, slings, and all other load handling accessories deducted from main boom ratings shown.
- The weight of bucket and materials must not exceed rated load.
- Optimum bucket should be required according to material. $\text{Bucket capacity (m}^3\text{)} \times \text{specified gravity of material (ton/m}^3\text{)} + \text{bucket weight (ton)} = \text{rated load}$.
- Bucket weight must also be decreased according to operating cycle and bucket lowering height.
- Rated loads are determined by stability and boom strength. During simultaneous operations of boom and swing, rapid acceleration or deceleration must be avoided.
- Do not attempt to cast the bucket while swinging or diagonal draw-cutting.

<Reference Information>

Main hoist loads

No. of Parts of Line	1
Maximum Loads (kN)	69
Maximum Loads (t)	7.0

Assembling the counterweight

22.8 ton counterweight
without carbody weight
(Standard type)

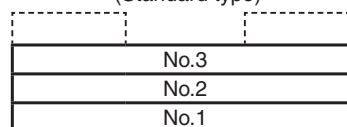

Counterweights

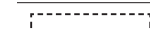

Carbody weights

Assembling the counterweight

(Equipped with self removal device)
17.7 ton counterweight
without carbody weight
(Optinal type)

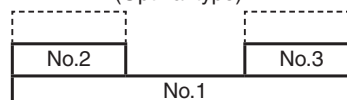

Counterweights

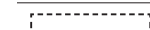

Carbody weights

- The lifting capacity does not change due to the type of counterweights. (Standard or optinal)

Operation of this equipment in excess of rated loads
or disregard of instruction voids the warranty.

LIFTING CAPACITIES



Clamshell Rating Charts Crane Boom Capacities

Counterweight: 22.8 t
Without Carbody Weight
Crawler Fully Extended

Unit: metric ton

Load radius (m) \ Boom length (m)	9.1	12.2	15.2	18.3	21.3				Boom length (m) \ Load radius (m)
5.0	7.0								5.0
5.5	7.0								5.5
6.0	7.0	7.0							6.0
7.0	7.0	7.0	7.0						7.0
8.0	7.0	7.0	7.0	7.0					8.0
9.0	7.0	7.0	7.0	7.0	7.0				9.0
10.0		7.0	7.0	7.0	7.0				10.0
12.0			7.0	7.0	7.0				12.0
14.0			7.0	7.0	7.0				14.0
16.0				7.0	7.0				16.0
18.0					7.0				18.0
20.0									20.0
22.0									22.0
24.0									24.0
26.0									26.0
28.0									28.0
30.0									30.0
32.0									32.0
34.0									34.0
36.0									36.0
38.0									38.0
40.0									40.0
42.0									42.0
44.0									44.0
Reeves	1	1	1	1	1				Reeves

Note:
Please refer rated chart in operator's cabin.

SUPPLEMENTAL DATA FOR REDUCED WEIGHTS RATING CHART

- Ratings according to EN13000.
- Operating radius is the horizontal distance from centerline of rotation to a vertical line through the center of gravity of the load.
- Deduct weight of hook block (s), slings and all other load handling accessories from main boom ratings shown.
- Ratings shown are based on freely suspended loads and make no allowance for such factors as wind effect on lifted load, ground conditions, out-of-level, operating speeds or any other condition that could be detrimental to the safe operation of this equipment. The operator, therefore, has the responsibility to judge the existing conditions and reduce lifted loads and operating speeds accordingly.
- Ratings are for operation on a firm and level surface, up to 1% gradient.
- At radii and boom lengths where no ratings are shown on chart, operation is not intended nor approved.
- Boom inserts and guy lines must be arranged as shown in the "operator's manual".
- Boom hoist reeving is 12 part line.
- Gantry must be in raised position for all conditions.
- Boom backstops are required for all boom lengths.
- The boom should be erected over the front of the crawlers, not laterally.
- Ratings inside of boxes are limited by strength of materials.
- The minimum rated load is 1.1 (ton).
- Crawler frames must be fully extended for all crane operations.

(Crane boom lifting)

- The total load that can be lifted is the value for weight of hook block, slings, and all other load handling accessories deducted from main boom ratings shown.

Main hoist loads

No. of Parts of Line	1	2	3	4	5
Maximum Loads (kN)	78	157	235	314	392
Maximum Loads (t)	8.0	16.0	24.0	32.0	40.0

No. of Parts of Line	6	7	8	9	10
Maximum Loads (kN)	471	549	628	706	785
Maximum Loads (t)	48.0	56.0	64.0	72.0	80.0

Auxiliary hoist loads

No. of Parts of Line	1
Maximum Loads (kN)	69
Maximum Loads (t)	7.0

Weight of hook block					
Hook Block	80 t	50 t	32 t	19 t	7.0 t Ball Hook
Weight (t)	0.8	0.7	0.5	0.4	0.16

Operation of this equipment in excess of rated loads or disregard of instruction voids the warranty.

<Reference Information>

Assembling the counterweight

22.8 ton counterweight
without carbody weight
(Standard type)

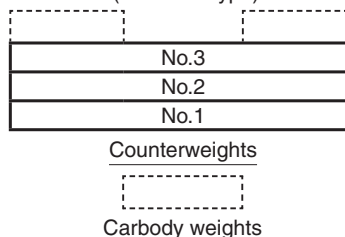

Assembling the counterweight

(Equipped with self removal device)
17.7 ton counterweight
without carbody weight
(Optinal type)

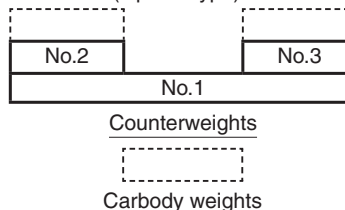

- The lifting capacity does not change due to the type of counterweights. (Standard or optional)

LIFTING CAPACITIES



Reduced Weights Rating Charts Crane Boom Lifting Capacities

Counterweight: 22.8 t
Without Carbody Weight
Crawler Fully Extended
Unit: metric ton

Load radius (m) \ Boom length (m)	9.1	12.2	15.2	18.3	21.3	24.4	27.4	30.5	33.5	36.6	39.6	Boom length (m) \ Load radius (m)
3.0	3.0m/73.8											3.0
3.5	68.7	3.6m/66.9										3.5
4.0	64.4	63.1	4.2m/58.4									4.0
4.5	55.4	55.4	53.3	4.7m/47.4								4.5
5.0	45.9	45.8	45.8	44.0	5.2m/38.9							5.0
5.5	39.2	39.1	39.0	39.0	37.2	5.7m/33.4						5.5
6.0	34.1	34.0	33.9	33.9	33.7	32.2	6.3m/29.2	6.8m/25.7				6.0
7.0	27.0	26.9	26.8	26.8	26.7	26.6	26.0	24.9	7.3m/22.7	7.9m/20.3		7.0
8.0	22.3	22.2	22.1	22.1	22.0	21.9	21.8	21.6	20.8	20.1	8.4m/18.4	8.0
9.0	19.0	18.9	18.7	18.7	18.6	18.5	18.4	18.3	18.3	17.7	17.1	9.0
10.0	9.2m/18.5	16.3	16.2	16.2	16.1	16.0	15.9	15.8	15.7	15.6	15.2	10.0
12.0		11.9m/12.9	12.7	12.6	12.5	12.4	12.3	12.2	12.2	12.0	12.0	12.0
14.0			10.3	10.3	10.2	10.1	10.0	9.8	9.8	9.7	9.6	14.0
16.0			14.5m/9.9	8.6	8.5	8.4	8.3	8.1	8.1	8.0	7.9	16.0
18.0				17.1m/7.9	7.2	7.1	7.0	6.9	6.8	6.7	6.6	18.0
20.0					19.8m/6.3	6.2	6.0	5.9	5.9	5.7	5.6	20.0
22.0						5.4	5.3	5.1	5.1	4.9	4.8	22.0
24.0						22.4m/5.3	4.6	4.5	4.4	4.3	4.2	24.0
26.0							25.1m/4.3	4.0	3.9	3.8	3.7	26.0
28.0								27.7m/3.5	3.5	3.3	3.2	28.0
30.0									3.1	2.9	2.8	30.0
32.0									30.3m/3.0	2.6	2.4	32.0
34.0										33.0m/2.3	2.1	34.0
36.0											35.0m/1.9	36.0
Reeves	10	9	8	6	5	5	4	4	3	3	3	Reeves

Load radius (m) \ Boom length (m)	42.7	45.7	48.8	51.8								Boom length (m) \ Load radius (m)
9.0	9.0m/16.5	9.4m/15.0										9.0
10.0	14.7	14.2	10.0m/13.7	10.5m/12.6								10.0
12.0	11.8	11.5	11.1	10.8								12.0
14.0	9.4	9.4	9.2	8.9								14.0
16.0	7.7	7.7	7.6	7.5								16.0
18.0	6.5	6.4	6.3	6.2								18.0
20.0	5.5	5.4	5.3	5.2								20.0
22.0	4.7	4.7	4.5	4.4								22.0
24.0	4.1	4.0	3.9	3.8								24.0
26.0	3.5	3.5	3.3	3.2								26.0
28.0	3.1	3.0	2.9	2.7								28.0
30.0	2.6	2.6	2.4	2.3								30.0
32.0	2.3	2.2	2.1	1.9								32.0
34.0	2.0	1.9	1.7	1.6								34.0
36.0	1.7	1.6	1.4	1.3								36.0
38.0	1.4	1.3	1.2	1.1								38.0
40.0	38.3m/1.3	1.1										40.0
42.0												42.0
44.0												44.0
46.0												46.0
48.0												48.0
50.0												50.0
Reeves	3	2	2	2								Reeves

Note:

Ratings according to EN13000.

Ratings shown in are determined by the strength of the boom or other structural components.

Lifting capacities may vary depending on hook used or with/without auxiliary sheave.

Please refer rated chart in operator's cabin.

SUPPLEMENTAL DATA FOR BARGE RATING CHART

- Operating radius is the horizontal distance from centerline of rotation to a vertical line through the center of gravity of the load.
- Deduct weight of hook block (s), slings and all other load handling accessories from main boom ratings shown.
- Condition of barge stability this rating chart were determined under the condition below. The stability of barge shall meet below condition. During operation the machinery static inclination against horizontal level.

(A) Both sides (right & left) of machine

Maximum inclination shall be within 1.5 degrees

(B) Front & backward of machine

Maximum inclination shall be within 3.0 degrees

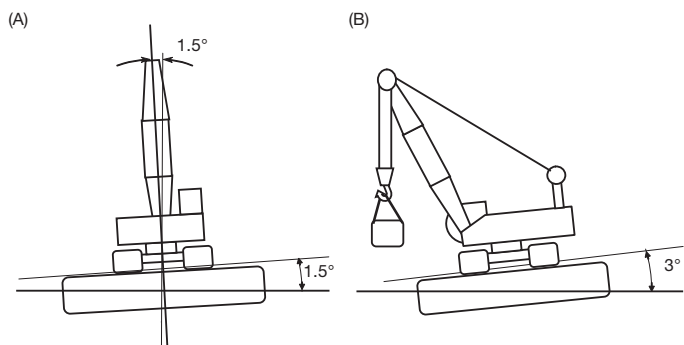
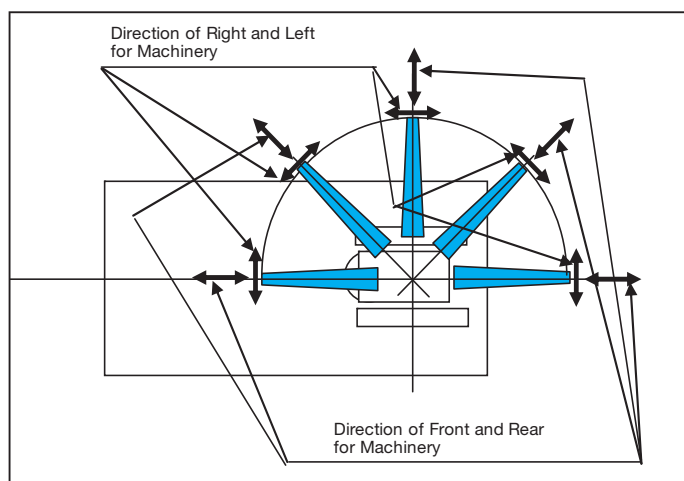

- Working area shall be inshore and smooth water.
- Applicable regulations for structure Japanese construction codes for mobile crane
 - ※ Regulation of class of shipping (abs, lloyd, bv, nk, etc) are not adapted.
- At radii and boom lengths where no ratings are shown on chart, operation is not intended nor approved.
- Boom inserts and guy lines must be arranged as shown in the "operator's manual".
- Boom hoist reeving is 12 part line.
- Gantry must be in raised position for all conditions.
- Boom backstops are required for all boom lengths.
- The boom should be erected over the front of the crawlers, not laterally.
- Ratings inside of boxes are limited by strength of materials.

- The minimum rated load is 1.1 (ton).
- Crawler frames must be fully extended for all crane operations.
- The machinery should be fastened to the deck of the barge to prevent tip over and sliding.
- Towing area
 - Towing area shall be within coastal area and quiet wave condition. Offshore and open sea is not considered for this machinery. Depend on the height of wave, counterweight shall be reduced during towing.

(Crane Boom)

- The total load that can be lifted is the value for weight of hook block, slings, and all other load handling accessories deducted from main boom ratings shown.

<Reference Information>

Main hoist loads

No. of Parts of Line	1	2	3	4	5
Maximum Loads (kN)	78	157	235	314	392
Maximum Loads (t)	8.0	16.0	24.0	32.0	40.0

No. of Parts of Line	6	7
Maximum Loads (kN)	471	490
Maximum Loads (t)	48.0	50.0

Auxiliary hoist loads

No. of Parts of Line	1
Maximum Loads (kN)	69
Maximum Loads (t)	7.0

Weight of Hook Block					
Hook Block	80 t	50 t	32 t	19 t	7.0 t Ball Hook
Weight (t)	0.8	0.7	0.5	0.4	0.16

Operation of this equipment in excess of rated loads or disregard of instruction voids the warranty.

Assembling the counterweight

27.2 ton counterweight
6.5 ton carbody weight
(Standard type)

No.4		No.5
No.3		
No.2		
No.1		

Counterweights

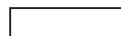

Carbody weights

Assembling the counterweight

(Equipped with self removal device)
26.1 ton counterweight
6.5 ton carbody weight
(Optimal type)

No.4		No.5
No.2		No.3
No.1		

Counterweights



Carbody weights

- The lifting capacity does not change due to the type of counterweights (standard or optimal)

LIFTING CAPACITIES



Barge Raiting Chart Crane Boom Lifting Capacities

Counterweight: 27.2 t
Carbody Weight: 6.5 t
Crawler Fully Extended
Unit: metric tons

Load radius (m)	12.2	15.2	18.3	21.3	24.4	27.4	30.5	33.5	36.6	Load radius (m)
4.0	4.2m/50.0	4.9m/40.2								4.0
5.0	39.7	39.5	5.6m/34.9							5.0
6.0	32.8	32.6	32.4	6.3m/30.7	6.9m/27.3					6.0
7.0	27.9	27.7	27.4	27.4	27.2	7.6m/24.5				7.0
8.0	24.2	24.1	23.8	23.7	23.5	23.4	8.3m/22.1			8.0
9.0	21.3	21.2	21.0	20.9	20.7	20.5	20.3	20.2	9.7m/18.3	9.0
10.0	18.5	18.4	18.3	18.3	18.2	18.1	18.0	18.0	17.8	10.0
12.0	11.8m/13.2	14.8	14.7	14.6	14.5	14.4	14.3	14.2	14.1	12.0
14.0		11.2	12.0	11.8	11.8	11.7	11.6	11.5	11.4	14.0
16.0		14.5m/10.2	10.1	10.0	9.9	9.7	9.6	9.5	9.4	16.0
18.0			17.1m/8.0	8.5	8.4	8.3	8.2	8.1	8.0	18.0
20.0				19.8m/7.0	7.2	7.1	7.1	7.0	6.9	20.0
22.0					6.4	6.3	6.1	6.0	5.9	22.0
24.0					22.4m/5.9	5.5	5.5	5.3	5.2	24.0
26.0						25.0m/5.1	4.8	4.7	4.6	26.0
28.0							27.7m/4.3	4.2	4.0	28.0
30.0								3.8	3.7	30.0
32.0								30.3m/3.7	3.3	32.0
34.0									33.0m/3.0	34.0
Reeves	7	6	5	4	4	4	3	3	3	Reeves

Note:

Ratings according to Japanese construction codes for mobile cranes and Japanese safety ordinance on cranes, etc.

Ratings shown in are determined by the strength of the boom or other structural components.

Lifting capacities may vary depending on hook used or with/without auxiliary sheave.

Please refer rated chart in operator's cabin.

TRANSPORTATION PLAN

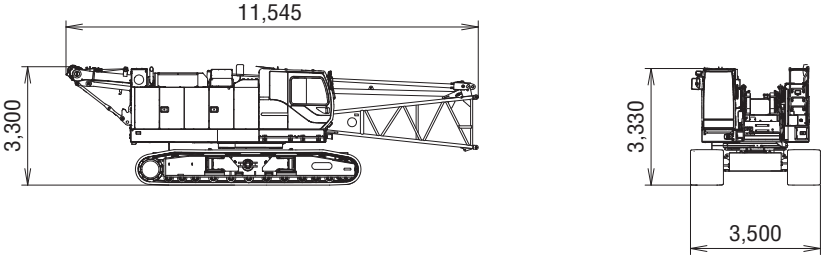
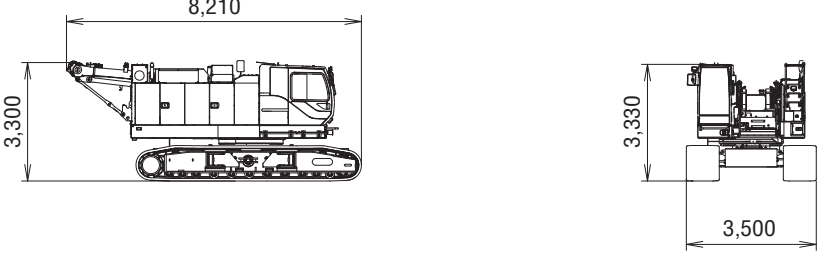
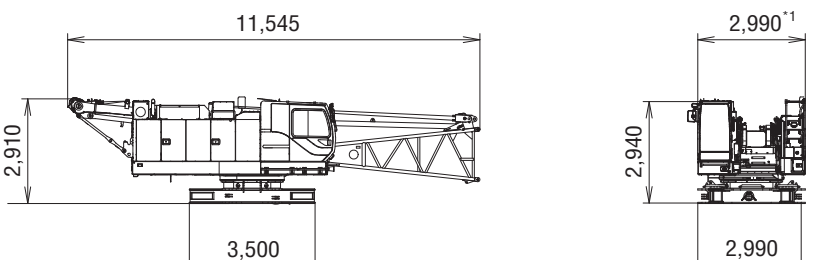
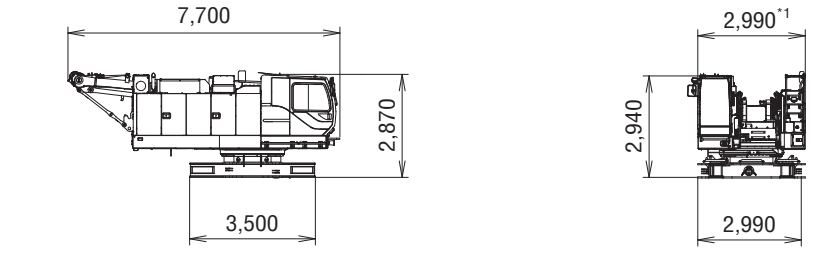
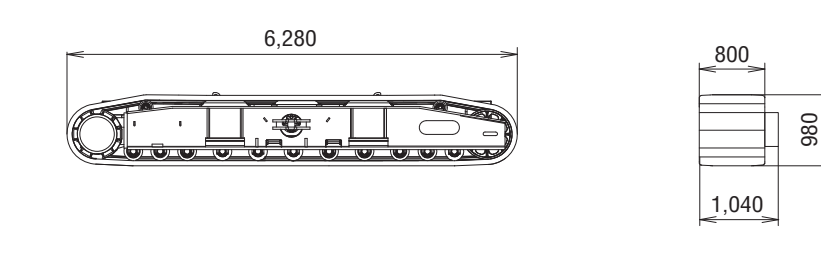
Name	Dimension	Weight (kg)
Base Machine <ul style="list-style-type: none"> • Boom base • Gantry • Crawler • Wire rope (Front / rear / boom hoist) 		39,850
Base Machine <ul style="list-style-type: none"> • Gantry • Crawler • Wire rope (Front / rear / boom hoist) 		37,880
Base Machine <ul style="list-style-type: none"> • Boom base • Gantry • Wire rope (Front / rear / boom hoist) • Without crawler • Without side steps 		25,490
Base Machine <ul style="list-style-type: none"> • Gantry • Wire rope (Front / rear / boom hoist) • Without crawler • Without side steps 		23,520
Crawler		7,180

*1 With the side step on cabin side : 3,170
With the side steps on the both sides : 3,340

PARTS AND ATTACHMENTS

Base Machine

Boom base, Gantry, Crawler, Wire rope (Front/rear/boom hoist)
Weight: 39,850 kg Width: 3,500 mm

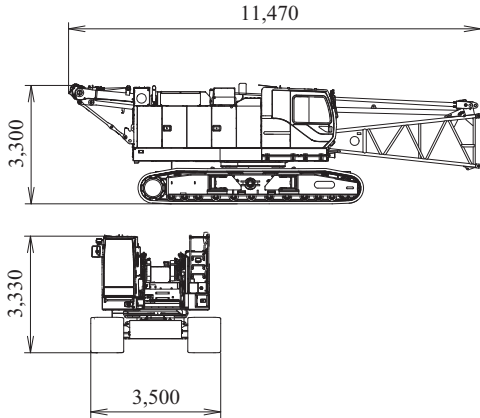

Crawler

Weight: 7,180 kg

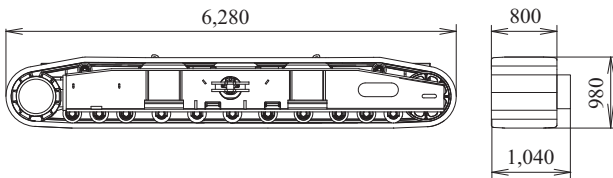

Backstop

Weight: 245 kg

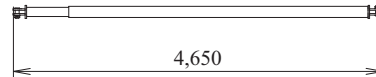

Jib Tip

Weight: 145 kg

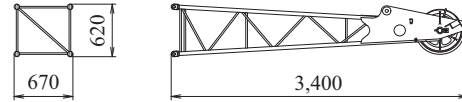

Jib Base

Weight: 125 kg

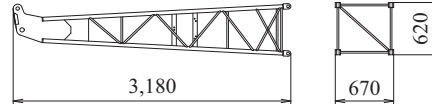

6.1 m

Jib Insert

Weight: 140 kg

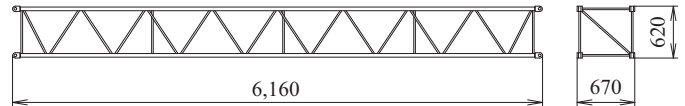

Jib Strut

Weight: 190 kg

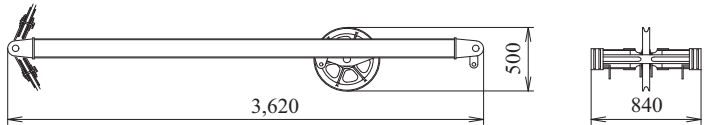

Counterweight No.1

Weight: 8,530 kg

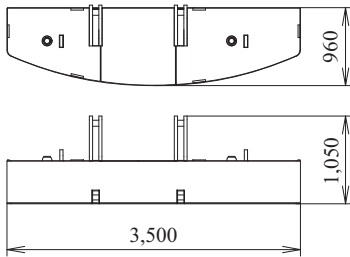

Counterweight No.4 (L)

Weight: 1,660 kg

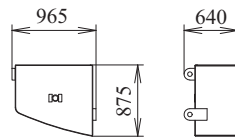

Counterweight (1) (Option)

Weight: 9,320 kg

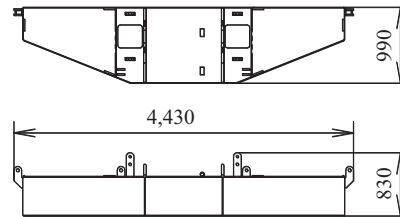

Counterweight No.2

Weight: 7,860 kg

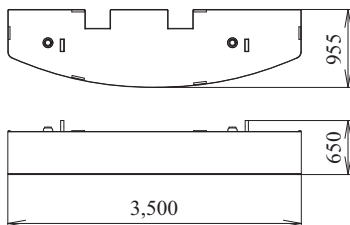

Counterweight No.4 (R)

Weight: 2,740 kg

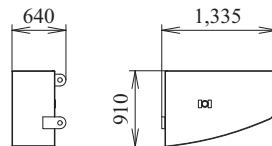

Counterweight (L) (2) (4) (Option)

Weight: 4,200 kg

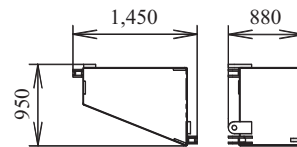

Counterweight (R) (3) (5) (Option)

Weight: 4,200 kg

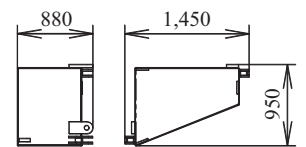

Counterweight No.3

Weight: 6,410 kg

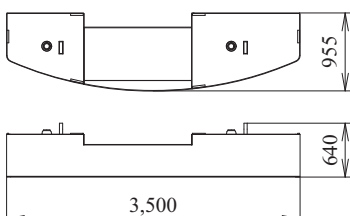

Carbody Weight

Weight: 3,270 kg / 1 piece

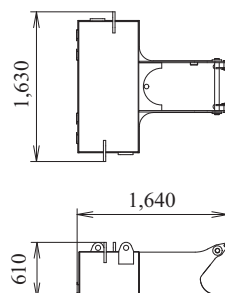

Self Removal Unit (Option)

Weight: 860 kg

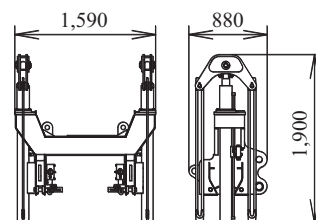

Boom Tip

Weight: 1,110 kg

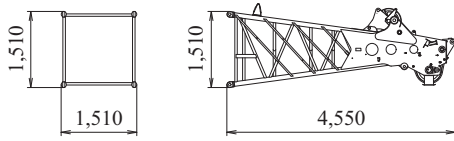

Boom Base

Weight: 1,130 kg

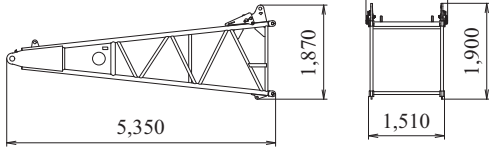

3.0 m Boom Insert

Weight: 311 kg

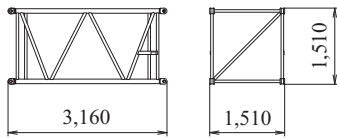

6.1 m Boom Insert

Weight: 522 kg

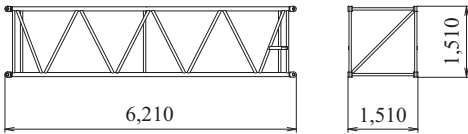

6.1 m Boom Insert With Lug

Weight: 545 kg

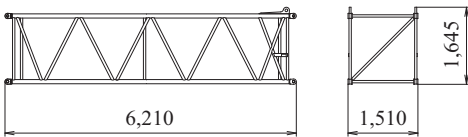

9.1 m Boom Insert

Weight: 742 kg

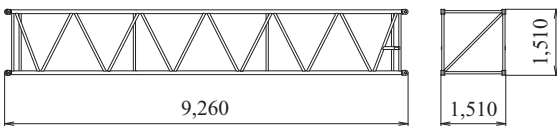

9.1 m Boom Insert With Lug

Weight: 765 kg

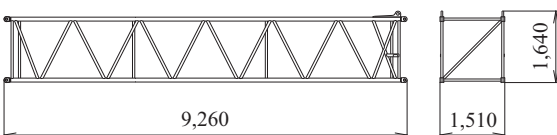

Auxiliary Sheave

Weight: 150 kg

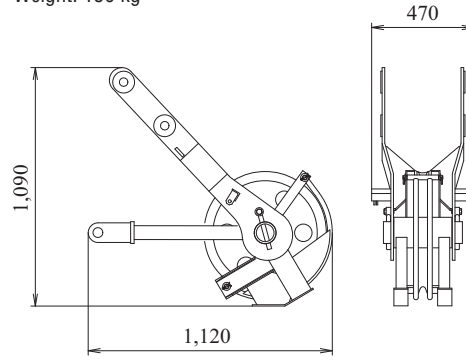

Upper Spreader

Weight: 280 kg

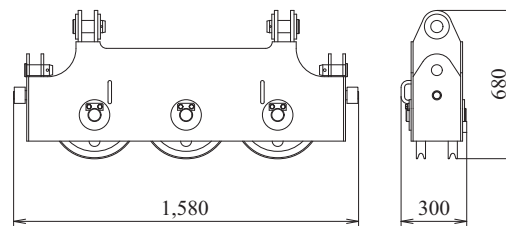

Lower Spreader

Weight: 215 kg

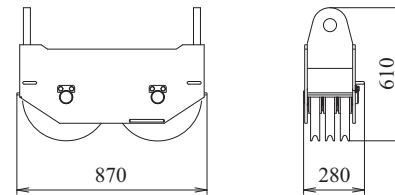

Ball Hook

Weight: 160 kg

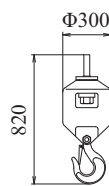

19 t Hook

Weight: 400 kg

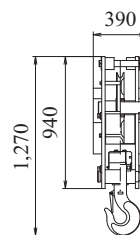

32 t Hook

Weight: 500 kg

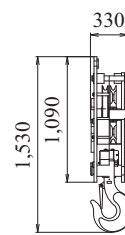

50 t Hook

Weight: 650 kg

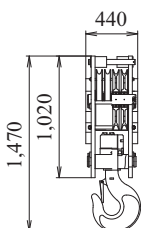

80 t Hook

Weight: 800 kg

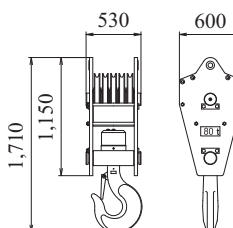



Note: This catalog may contain photographs of machines with specifications, attachments and optional equipment not certified for operation in your country. Please consult KOBELCO for those items you may require. Due to our policy of continual product improvements all designs and specifications are subject to change without advance notice.

Copyright by KOBELCO CRANES CO., LTD. No part of this catalog may be reproduced in any manner without notice.

KOBELCO CRANES CO., LTD.

17-1, Higashigotanda 2-chome, Shinagawa-ku, Tokyo 141-8626 JAPAN

Tel: +81-3-5789-2130 Fax: +81-3-5789-3372

URL: <http://www.kobelco-cranes.com/>

Inquiries To: